

**DVI 005 M, DVI 205 M**  
Mini In-line Valve, electromagnetically operated

## Operating Instructions

EN

BP 5121 BEN (2010-06)

## Product Identification

In all communications with Pfeiffer Vacuum, please specify the information on the product nameplate. For convenient reference copy that information into the space provided below.

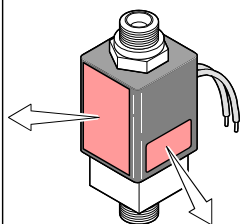
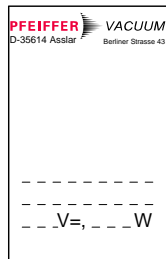

Pfeiffer Vacuum, D-35614 Asslar  
F-No: .....

## Validity

This document applies to products with part numbers

PF H13 232 (DVI 005 M, NC)  
PF H13 233 (DVI 205 M, NO)

The part number (No) can be taken from the product nameplate.

If not indicated otherwise in the legends, the illustrations in this document correspond to the valve DVI 005 M. They apply to the valve DVI 205 M by analogy.

We reserve the right to make technical changes without prior notice.

All dimensions in mm.

## Intended Use

The Mini In-line Valves DVI 005 M and DVI 205 M are predominantly used in fast-cycling vacuum systems, e.g. for gas analysis and coating processes.

## Functional Principle

**DVI 005 M (NC)** It is opened electromagnetically and closed by the prestressed pressure spring. It closes automatically in the event of a power failure.

**DVI 205 M (NO)** It is opened by the prestressed pressure spring and closed electromagnetically. It opens automatically in the event of a power failure.

## Safety

### Symbols Used

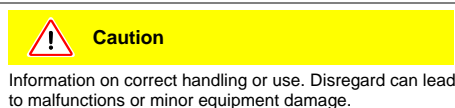
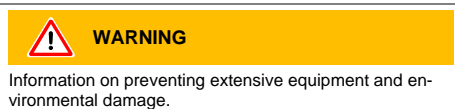
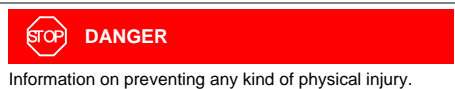

### Personnel Qualifications

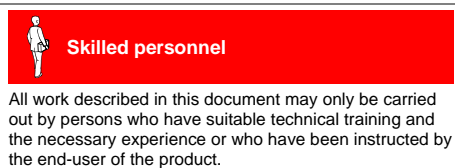

### General Safety Instructions

- Adhere to the applicable regulations and take the necessary precautions for the process media used. Consider possible reactions between the materials (→ "Technical Data") and the process media. Consider possible reactions of the process media due to the heat generated by the product.
- Adhere to the applicable regulations and take the necessary precautions for all work you are going to do and consider the safety instructions in this document.
- Before beginning to work, find out whether any vacuum components are contaminated. Adhere to the relevant regulations and take the necessary precautions when handling contaminated parts.

Communicate the safety instructions to all other users.

### Liability and Warranty

Pfeiffer Vacuum assumes no liability and the warranty becomes null and void if the end-user or third parties

- disregard the information in this document
- use the product in a non-conforming manner
- make any kind of interventions (modifications, alterations etc.) on the product
- use the product with accessories not listed in the corresponding product documentation.

The end-user assumes the responsibility in conjunction with the process media used.

Failures due to contamination or wear and tear, as well as expendable parts (e.g. seals), are not covered by the warranty.

## Technical Data

Version DVI 005 M (NC) DVI 205 M (NO)	normally closed normally open
Nominal diameter	ø5 mm / M14x1
Vacuum connections (accessories)	<ul style="list-style-type: none"> <li>flange fitting DN 10 ISO-KF</li> <li>pipe connection OD ¼"</li> <li>pipe connection OD 6 mm</li> </ul>
Power connection Voltage Power	24 VDC ±10% 10 W
Duty cycle	100% (i.e. continuous duty possible)
Degree of protection	IP 65
Conductance for air Molecular flow Laminar flow	0.2 l/s 2 l/s
Mounting orientation	any
Switching frequency max.	300 / min <sup>1)</sup>
Cycles to first maintenance	≈2 million <sup>2)</sup>
Tightness	1×10 <sup>-9</sup> mbar l/s
Resistance to pressure	10 bar (absolute)
Operating pressure DVI 005 M DVI 205 M	1×10 <sup>-9</sup> mbar ... 1 bar 1×10 <sup>-9</sup> mbar ... 2 bar
Pressure difference Δp In closing direction DVI 005 M DVI 205 M	5 bar 4 bar
In opening direction DVI 005 M DVI 205 M	1.5 bar 2 bar
Opens against a pressure difference Δp DVI 005 M DVI 205 M	1 bar with 24 VDC 4 bar with 24 VDC
Closing time DVI 005 M DVI 205 M	7 ms <sup>1)</sup> 30 ms <sup>1)</sup>
Opening time DVI 005 M DVI 205 M	30 ms <sup>1)</sup> 10 ms <sup>1)</sup>
Temperatures Ambiance Heat generation	5 <sup>3)</sup> ... 40 °C 60 °C (after 1 h 15 min continuous duty)
Bakeout	120 °C (with idle coil) 150 °C (without coil)
Materials Housing Connecting nut Actuator Seals	stainless steel 1.4301 stainless steel 1.4301 stainless steel 1.4105 FPM
Weight	0.3 kg

<sup>1)</sup> With pressure difference Δp = 0 bar.

<sup>2)</sup> Under clean operating conditions. If the valve is operated under harsh or dirty conditions, it should be cleaned / maintained before the specified service time to maintenance has been reached.

<sup>3)</sup> -15 °C, if the ambiance is free of condensable gases.

**Dimensions [mm]**

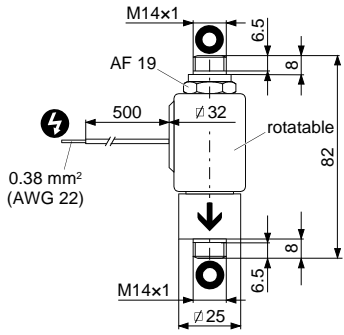

- Power connection
- Protective lid
- Flow direction

**Installation dimensions with accessories [mm]**  
(ordering numbers → "Installation")

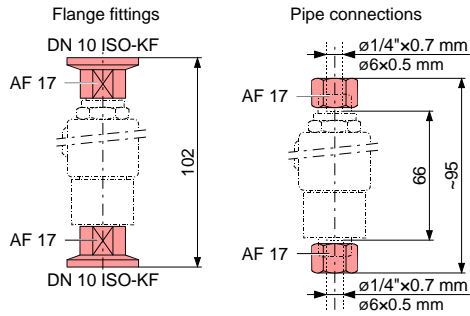

**Flange fitting and pipe connections**

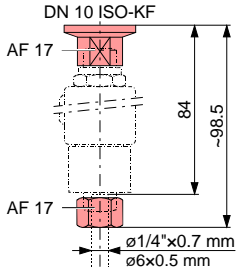

**Accessories (1 piece per part number)**

 Part no. PT 420 912-T	 Pipe connection OD 6 mm $\phi 6 \times 0.5 \text{ mm}$ Part no. PT 420 914-T
 Pipe connection OD 1/4" $\phi 1/4 \times 0.7 \text{ mm}$ Part no. PT 420 913-T	 Flange fitting DN 10 ISO-KF Part no. PT 420 912-T
 Pipe connection OD 6 mm $\phi 6 \times 0.5 \text{ mm}$ Part no. PT 420 914-T	

**Flange connections**

**1** Remove the protective lids and mount two flange fittings.

**Installation**

**Vacuum Connection**

**Caution**

Caution: vacuum component  
Dirt and damages impair the function of the vacuum component.  
When handling vacuum components, take appropriate measures to ensure cleanliness and prevent damages.

**Caution**

Caution: dirt sensitive area  
Touching the product or parts thereof with bare hands increases the desorption rate.  
Always wear clean, lint-free gloves and use clean tools when working in this area.

**2** Remove the protective lids and install the product to the vacuum system.

**STOP DANGER**

**DANGER:** overpressure in the vacuum system >1 bar  
Injury caused by released parts and harm caused by escaping process gases can result if clamps are opened while the vacuum system is pressurized.  
Do not open any clamps while the vacuum system is pressurized. Use the type of clamps which are suited to overpressure.

**STOP DANGER**

**DANGER:** overpressure in the vacuum system >2.5 bar  
KF flange connections with elastomer seals (e.g. O-rings) cannot withstand such pressures. Process media can thus leak and possibly damage your health.  
Use O-rings provided with an outer centering ring.

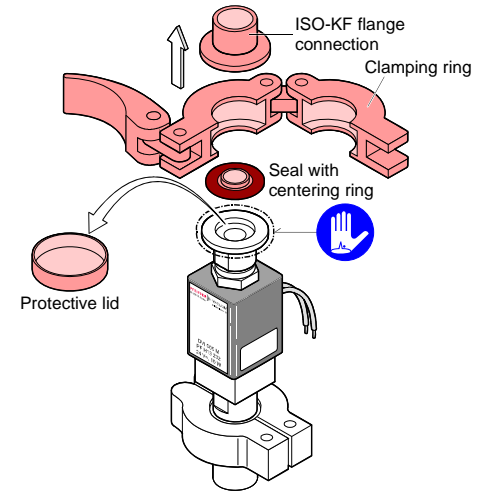

- Keep the protective lids.
- 3** Check that the vacuum connections are leak tight.

**Tube connections**

- 1** Cut the tube to the required length and remove the burs.
- 2** Slide the union nut and clamping rings over the tube.

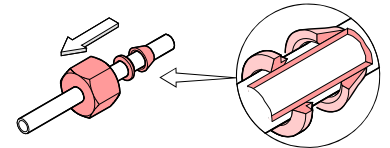

- 3** Remove the protective lid and insert the tube until the mechanical stop is reached.

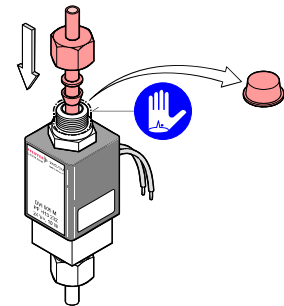

- Keep the protective lids.
- 4** Slide the clamping rings up to the mechanical stop.

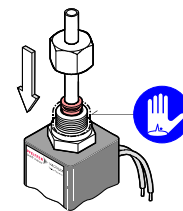

- 5 Tighten the union nut with your fingers.

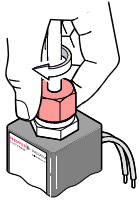

- 6 Tighten the union nut

- initial installation by 3/4 turns (stainless steel)
- subsequent installation by 1/4 turns (stainless steel).

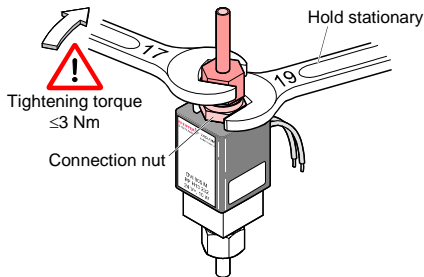

- 7 Check that the vacuum connections are leak tight.

## Power Connection

### Caution



Caution: switching of inductive loads (solenoid coil)

Inductive loads may considerably reduce the life of or even destroy contacts.

Preferably a clamping diode should be connected in parallel to the solenoid coil. The polarity should be chosen in such a way that the diode blocks when the normal operating voltage is applied.

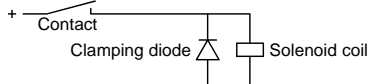

Before connecting or disconnecting the product, turn off the control system.

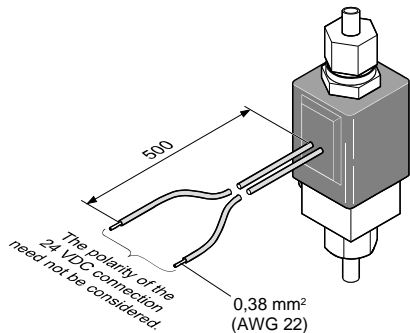

## Operation

The product is ready for operation as soon as it has been installed.

DVI 005 M (NC) It closes automatically in the event of a power failure.

DVI 205 M (NO) It opens automatically in the event of a power failure.

### STOP DANGER



DANGER: hot surface

Touching the hot surface (>55 °C) can cause burns.

Wear protective gloves.

## Deinstallation

### STOP DANGER



DANGER: contaminated parts

Contaminated parts can be detrimental to health and environment.

Before beginning to work, find out whether any parts are contaminated. Adhere to the relevant regulations and take the necessary precautions when handling contaminated parts.

### Caution



Caution: vacuum component

Dirt and damages impair the function of the vacuum component.

When handling vacuum components, take appropriate measures to ensure cleanliness and prevent damages.

### Caution



Caution: dirt sensitive area

Touching the product or parts thereof with bare hands increases the desorption rate.

Always wear clean, lint-free gloves and use clean tools when working in this area.

### Preconditions:

- Vacuum system vented
- Valve cooled down to <math>< 55\text{ °C}</math>

- 1 Disconnect the product from the power source.



Before connecting or disconnecting the product, turn off the control system.

- 2 Remove the valve from the vacuum system and install the protective lids.

### Flange connections

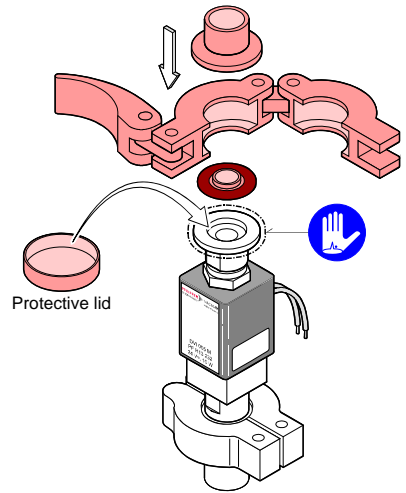

### Pipe connections

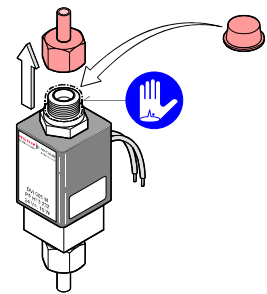

## Maintenance, Repair

Under clean operating conditions the product requires no maintenance during the rated cycle life.



Failures due to contamination or wear and tear, as well as expendable parts (e.g. seals), are not covered by the warranty.

### STOP DANGER



DANGER: contaminated parts

Contaminated parts can be detrimental to health and environment.

Before beginning to work, find out whether any parts are contaminated. Adhere to the relevant regulations and take the necessary precautions when handling contaminated parts.

### Caution



Caution: vacuum component

Dirt and damages impair the function of the vacuum component.

When handling vacuum components, take appropriate measures to ensure cleanliness and prevent damages.

### Caution



Caution: dirt sensitive area

Touching the product or parts thereof with bare hands increases the desorption rate.

Always wear clean, lint-free gloves and use clean tools when working in this area.

**Precondition:** Valve deinstalled.

- 1 Unfasten and remove the connection nut.

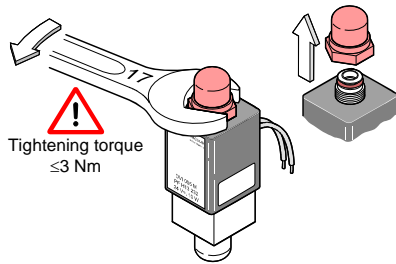

- 2 Remove the solenoid coil.

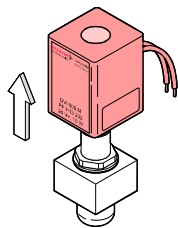

- 3 Unscrew the guiding tube ...

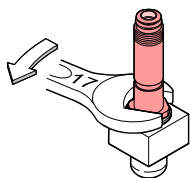

... and disassemble it.

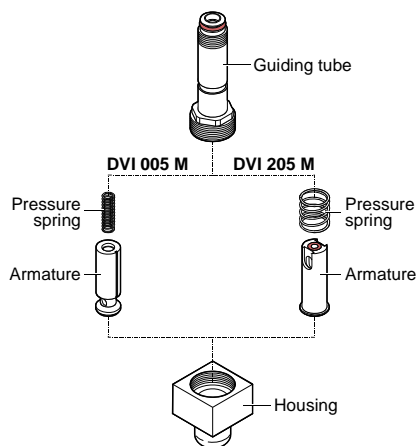

- 4 Remove the O-rings.

When reassembling the product, be careful to insert the O-rings level into the grooves without twisting them.

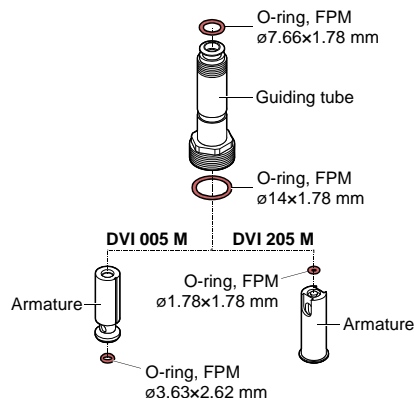

- 5 Clean the valve and replace its parts (→ "Spare Parts").

**STOP DANGER**

**DANGER: cleaning agents**  
Cleaning agents can be detrimental to health and environment.  
Adhere to the relevant regulations and take the necessary precautions when handling cleaning agents and disposing of them. Consider possible reactions with the product materials.

- Carefully clean the parts with a grease solving, non-scouring cleaner.
- After cleaning, the parts should preferably be rinsed with alcohol and subsequently heated to  $\approx 50^\circ\text{C}$  in an oven or with an industrial blower.
- Carefully clean the sealing surfaces with a lint-free cloth moistened with alcohol. Allow them to dry.
- Wipe the seals with a lint-free cloth slightly moistened with vacuum oil.

- 6 Proceed in reverse order to reassemble the valve.

After reassembly, a few switching cycles should be performed in order for the O-rings to perfectly adapt to the sealing surfaces.

### Spare Parts

When ordering spare parts, always indicate:

- All information on the product nameplate
- Description and ordering number according to the spare parts list

Seal kit, comprising 5x O-ring, FPM 75, $\varnothing 1.78 \times 1.78$ 5x O-ring, FPM 75, $\varnothing 7.66 \times 1.78$ 5x O-ring, FPM 75, $\varnothing 3.63 \times 2.62$ 5x O-ring, FPM 75, $\varnothing 14 \times 1.78$	Ordering number PT 130 165-T
<b>DVI 005 M</b> (normally closed)	Ordering number
Spare parts kit, comprising 1x solenoid coil 24 VDC / 10 W <sup>1)</sup> 1x pressure spring 1x O-ring, FPM 75, $\varnothing 7.66 \times 1.78$ mm 1x O-ring, FPM 75, $\varnothing 14 \times 1.78$ mm 1x O-ring, FPM 75, $\varnothing 3.63 \times 2.62$ mm	Ordering number BN 841 321-T
<b>DVI 205 M</b> (normally open)	Ordering number
Spare parts kit, comprising 1x solenoid coil 24 VDC / 10 W <sup>1)</sup> 1x pressure spring 1x O-ring, FPM 75, $\varnothing 7.66 \times 1.78$ mm 1x O-ring, FPM 75, $\varnothing 14 \times 1.78$ mm 1x O-ring, FPM 75, $\varnothing 1.78 \times 1.78$ mm	Ordering number BN 841 322-T

<sup>1)</sup> The included hexagonal nut is not needed

### Returning the Product

**WARNING**

**WARNING: forwarding contaminated products**  
Contaminated products (e.g. radioactive, toxic, caustic or biological hazard) can be detrimental to health and environment.  
Products returned to Pfeiffer Vacuum should preferably be free of harmful substances. Adhere to the forwarding regulations of all involved countries and forwarding companies and enclose a duly completed declaration of contamination <sup>1)</sup>.

<sup>1)</sup> Form under [www.pfeiffer-vacuum.net](http://www.pfeiffer-vacuum.net)

Products that are not clearly declared as "free of harmful substances" are decontaminated at the expense of the customer.

Products not accompanied by a duly completed declaration of contamination are returned to the sender at his own expense.

### Disposal

**STOP DANGER**

**DANGER: contaminated parts**  
Contaminated parts can be detrimental to health and environment.  
Before beginning to work, find out whether any parts are contaminated. Adhere to the relevant regulations and take the necessary precautions when handling contaminated parts.

**WARNING**

**WARNING: substances detrimental to the environment**  
Products or parts thereof (mechanical and electric components, operating fluids etc.) can be detrimental to the environment.  
Dispose of such substances in accordance with the relevant local regulations.

### Separating the components

After disassembling the product, separate its components according to the following criteria:

- Contaminated components  
Contaminated components (radioactive, toxic, caustic, or biological hazard etc.) must be decontaminated in accordance with the relevant national regulations, separated according to their materials, and disposed of.
- Other components  
Such components must be separated according to their materials and recycled.

**PFEIFFER VACUUM**

Berliner Straße 43  
D-35614 Asslar  
Deutschland  
Tel +49 (0) 6441 802-0  
Fax +49 (0) 6441 802-202  
[info@pfeiffer-vacuum.de](mailto:info@pfeiffer-vacuum.de)  
[www.pfeiffer-vacuum.net](http://www.pfeiffer-vacuum.net)